

1W & 3W High Power Purple LED Technical Data Sheet

Part No.: DL-HP10UV

Double Light

◆ Features:

- 1.High power LED type.
- 2.Small package with high efficiency.
- 3.High flux output and high luminance.
- 4.Instant light (less than 100ns).
- 5.Very long operating life (up to100k hours).
- 6.Low voltage DC operated.
- 7.Designed for high current operation.
- 8.Low thermal resistance.
- 9.Compatible with automatic placement equipment.
10. Wide viewing angle: 130°.
11. High reliable.
12. The product itself will remain within RoHS compliant Version.

◆ Descriptions:

1. The HP10 series is available in soft red, orange, yellow, green, blue and white. Due to the package design, the LED has wide viewing angle and optimized light coupling by inter reflector. This feature makes the SMT LED ideal for light pipe application.
2. This package LEDs are designed for high current operation and high flux output application. But the package's design features better thermal management characteristics than other LED solutions.

◆ Applications:

1. Counterfeit bill detection.
2. Sterilization.
3. Medical instrument.
4. Industrial use.
5. Photo catalyst excitation.
6. Phosphor excitation.
7. Sensor.
8. QA equipment.

Double Light

◆ Package Dimensions:

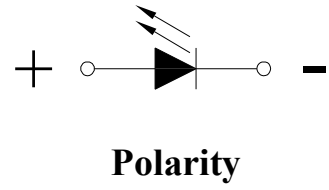
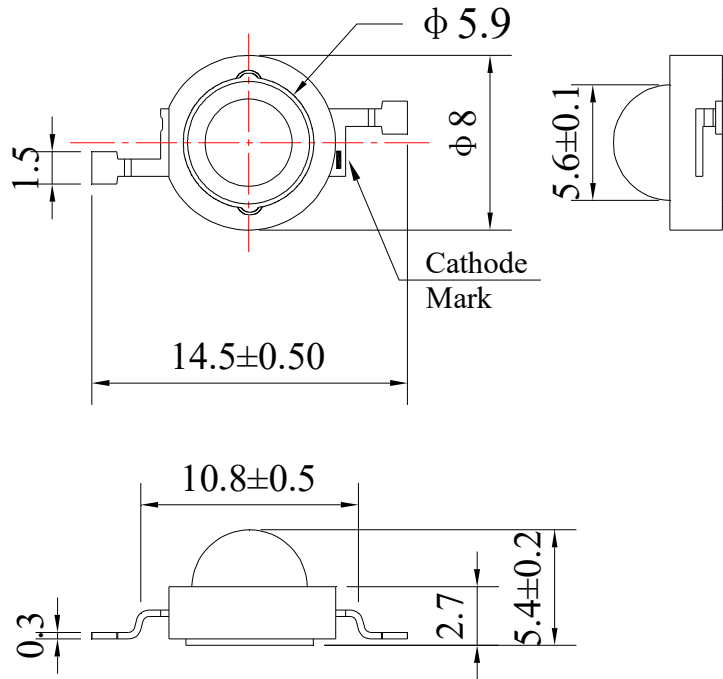

Unit: mm
Tolerance: ± 0.15 mm

Part No.	Chip Material	Lens Color	Source Color
DL-HP10UV	InGaN	Water Clear	Purple

Double Light

◆ Absolute Maximum Ratings at Ta=25°C

Parameters	Symbol	Rating	Units
Power Dissipation	PD	1400	mW
		2800	
Peak Pulse Forward Current (1/10 Duty Cycle, 0.1ms Pulse Width)	IFP	500	mA
		1000	
DC Forward Current	IF	350	mA
		700	
Reverse Voltage	VR	5	V
Operating Temperature Range	Topr	-20 to +80	°C
Storage Temperature Range	Tstg	-30 to +100	°C
Soldering Temperature	Tsol	260°C for 5 Seconds (Max.)	

Notes:

1. It is strongly recommended that the temperature of lead be not higher than 55°C.
2. Proper current derating must be observed to maintain junction temperature below the maximum.
3. LEDs are not designed to be driven in reserve bias.

◆ Electrical Optical Characteristics at Ta=25°C

Parameters	Symbol	Min.	Typ.	Max.	Unit	Test Condition
Luminous Intensity [1]	IV	320	340	360	mW/Sr	IF=350mA (HP60)
		525	560	590		IF=700mA (HP70)
Viewing Angle [2]	$2\theta_{1/2}$	---	130	---	Deg	IF=350mA/700mA
Peak Emission Wavelength[3]	λ_p	---	395	---	nm	IF=350mA/700mA
Dominant Wavelength	λ_d	---	405	---	nm	IF=350mA/700mA
Spectral Bandwidth	$\Delta\lambda$	---	15	---	nm	IF=350mA/700mA
Forward Voltage	VF	2.80	3.50	4.00	V	IF=350mA
		3.00	3.70	4.20		IF=700mA
Reverse Current	IR	---	---	50	μ A	$V_R=5V$

Notes:

1. Luminous Intensity Measurement allowance is $\pm 10\%$.
2. $\theta_{1/2}$ is the off-axis angle at which the luminous intensity is half the axial luminous intensity.
3. The dominant wavelength (λ_d) is derived from the CIE chromaticity diagram and represents the single wavelength which defines the color of the device.

Double Light

◆ Typical Electrical-Optical Characteristics Curves (25°C Ambient Temperature Unless Otherwise Noted)

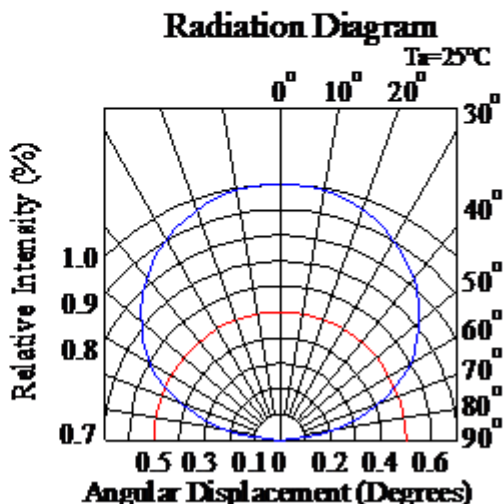
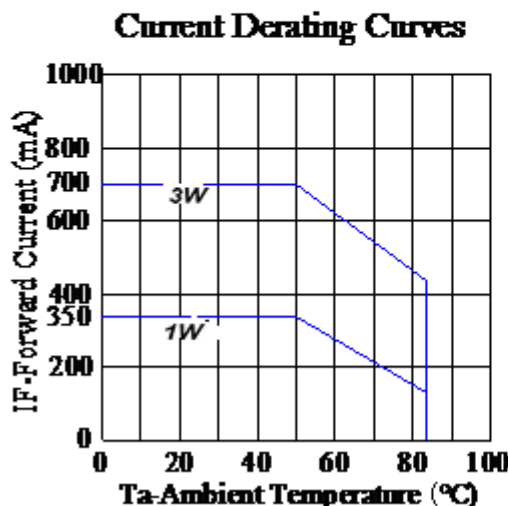
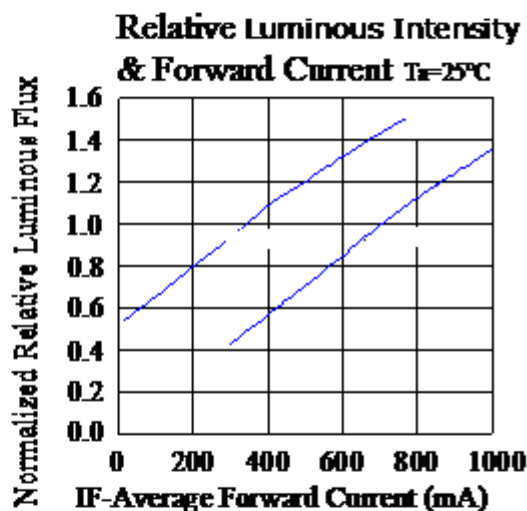
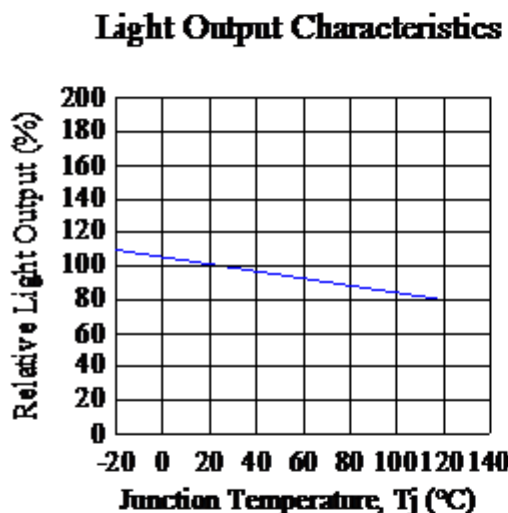
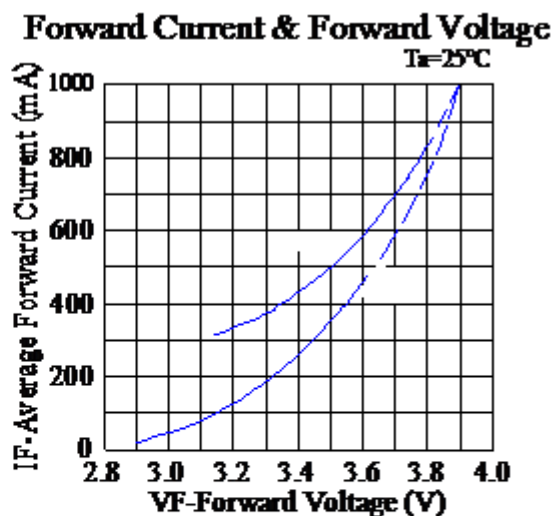
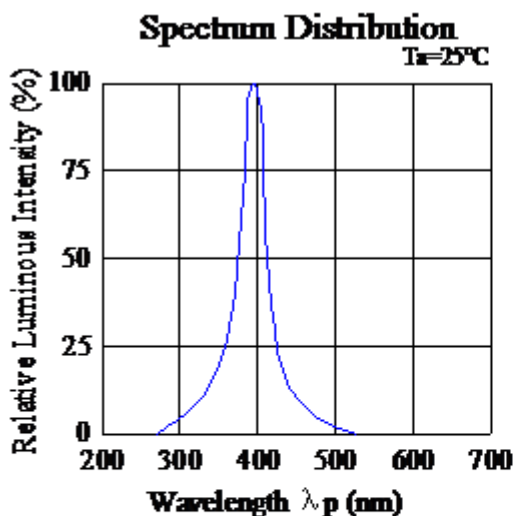

Double Light

◆ Reliability Test Items and Conditions:

The reliability of products shall be satisfied with items listed below:

Confidence level: 90%.

LTPD: 10%.

1) Test Items and Results:

No.	Test Item	Test Hours/Cycles	Test Conditions	Sample Size	Ac/Re
1	Resistance to Soldering Heat	6 Min	Tsld=260±5℃, Min. 5sec	25pcs	0/1
2	Thermal Shock	300 Cycles	H: +100℃ 5min f 10 sec L: -10℃ 5min	25pcs	0/1
3	Temperature Cycle	300 Cycles	H: +100℃ 15min f 5min L: -40℃ 15min	25pcs	0/1
4	High Temperature Storage	1000Hrs.	Temp: 100℃	25pcs	0/1
5	DC Operating Life	1000Hrs.	IF=350mA	25pcs	0/1
			IF=700mA		
6	Low Temperature Storage	1000Hrs.	Temp: -40℃	25pcs	0/1
7	High Temperature/ High Humidity	1000Hrs.	85℃/85%RH	25pcs	0/1

2) Criteria for Judging the Damage:

Item	Symbol	Test Conditions	Criteria for Judgment	
			Min	Max
Forward Voltage	VF	IF=350mA/IF=700mA	---	F.V.*)×1.1
Reverse Current	IR	VR=5V	---	F.V.*)×2.0
Luminous Intensity	IV	IF=350mA/IF=700mA	F.V.*)×0.7	---

*) F.V.: First Value.

Double Light

◆ Precautions For Use:

1. Over-current-proof

Though the high power LED has conducted ESD protection mechanism, customer must not use the device in reverse and should apply resistors for extra protection. Otherwise slight voltage shift may cause enormous current change and burn out failure would happen.

2. Storage

- ① Do not open moisture proof bag before the products are ready to use.
- ② Before opening the package, the LEDs should be kept at 30°C or less and 90%RH or less.
- ③ The LEDs should be used within a year.
- ④ After opening the package, the LEDs should be kept at 30°C or less and 70%RH or less.
- ⑤ The LEDs should be used within 168 hours (7 days) after opening the package.
- ⑥ If the moisture absorbent material (silicone gel) has faded away or the LEDs have exceeded the storage time, baking treatment should be performed using the following conditions.

- ⑦ Pre-curing treatment: 60±5°C for 24 hours.

3. Thermal Management

① Because the LED is a high power dissipation device, special and sufficient consideration in thermal management design must be made to optimize the thermal performance.

② Heat sink design is implemented in the device for an additional thermal connection. Since the device is capable of SMT process, tin must be spread both heat sink and solder pads areas to dissipate the heat.

③ A high thermal conductivity substrate, such as Aluminum or Copper plate etc, must be applied for external thermal management. It is strongly recommended that the outer heat sink or PCB dimension per LED can not be less than 25 × 25 × 1 (L × W × H) mm. The materials for outer heat sink can be FR4 on Aluminum, MCPCB, or FPC on Aluminum.

④ Special thermal designs are also recommended to take in outer heat sink design, such as FR4 PCB on Aluminum with thermal vias or FPC on Aluminum with thermal conductive adhesive, etc.

⑤ Sufficient thermal management must be conducted, or the die junction temperature will be over the limit under large electronic driving and LED lifetime will decrease critically.

4. Soldering Condition

- ① Soldering should not be done more than two times.
- ② While soldering, do not put stress on the LEDs during heating.
- ③ After soldering, do not warp the circuit board.

5. Soldering Iron

① For prototype builds or small series production runs it is possible to place and solder the LED by hand.

② Dispensing thermal conductive glue or grease on the substrates and follow its curing spec. Press LED housing to closely connect LED and substrate.

③ It is recommended to hand solder the leads with a solder tip temperature of 280°C for less than 3 seconds within once in less than the soldering iron capacity 25W. Leave two seconds and more intervals, and do soldering of each terminal.

④ Be careful because the damage of the product is often started at the time of the hand solder.

6. Handling Indications

- ① During processing, mechanical stress on the surface should be minimized as much as possible.
- ② Sharp objects of all types should not be used to pierce the sealing compound.

Double Light

7. Caution in ESD

Static Electricity and surge damages the LED. It is recommended to use a wrist band or anti-electrostatic glove when handling the LED. All devices equipment and machinery must be properly grounded.